

ICS series

ICS-500

Narada's ICS series battery designed to provide highcycling and fast charge performance, idea for telecom service where power supply is unstable. With innovative structure design, high quality manufacturing and high quality material, ICS batteries are also capable of PSoC, hybrid, renewable energy storage application and other cycling/standby applications.



Specifications

Battery Model	ICS-500	
Nominal voltage	2V	
Capacity	500Ah (10HR ,50A, 1.80V, 25°C)	
Approx.Weight	32.5kg	
Internal Resistance	Approx 0.33mΩ	
Max Charge Current Allowed	125A	
Charge Voltage (25°C)	Cycle use	Float use
	2.35V/cell	2.25V/cell
Temperature Ranges	Operation(maximum): -40°C to 55°C (-40°F to 131°F)	
	Operation(recommended): 15°C to 25°C (59°F to 77°F)	
	Storage: -20°C to 40°C (-4°F to 104°F)	
Terminal	M8 Female	
Terminal Hardware	15 ± 1.0 N.m	
Container Material	ABS (V0 optional)	

Dimensions (mm)

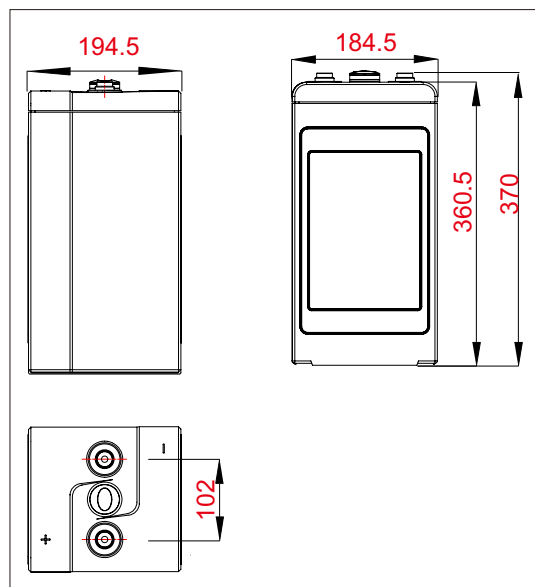

Constant Current Discharge Data Units: Amperes (25°C, 77°F)

End voltage per cell	15min	20min	30min	40min	50min	1h	2h	3h	5h	8h	10h
1.65V	600	533	422	740	350	287	175	133	92.0	63.0	55.0
1.70V	550	508	408	720	333	283	172	130	87.0	60.0	53.0
1.75V	517	467	383	670	308	280	170	128	83.0	58.0	52.0
1.80V	450	425	367	630	275	277	167	127	80.0	57.0	51.0

Constant Power Discharge Data Units: Watts per cell (25°C, 77°F)

End voltage per cell	15min	20min	30min	40min	50min	1h	2h	3h	5h	8h	10h
1.65V	1150	1020	880	740	650	555	365	285	205	163	120
1.70V	1070	990	830	720	630	545	355	280	200	158	115
1.75V	1010	920	775	670	610	535	350	275	195	153	110
1.80V	910	830	715	630	550	520	340	265	175	140	105

ICS series

ICS-500

Discharge Voltage vs Time Curve (25°C)

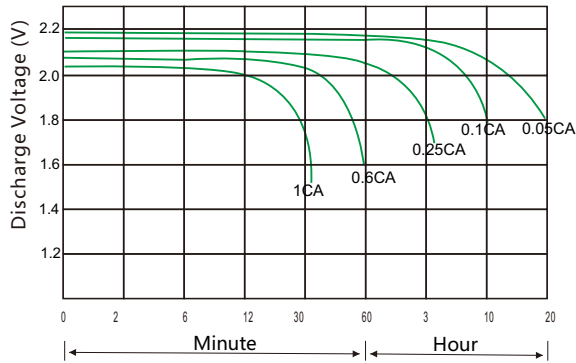

Charge Curve (25°C)

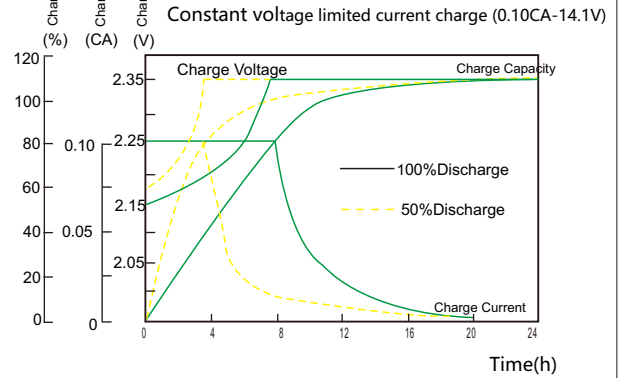

Capacity vs temperature curve

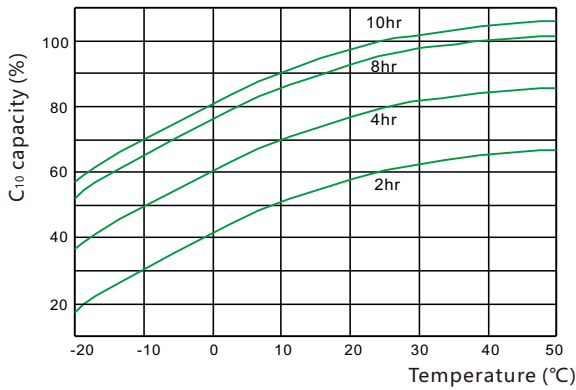

Residual Capacity vs Storage Time

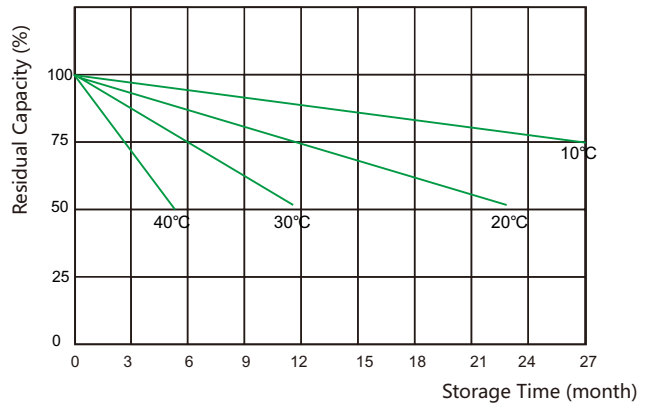

Capacity vs OCV curve

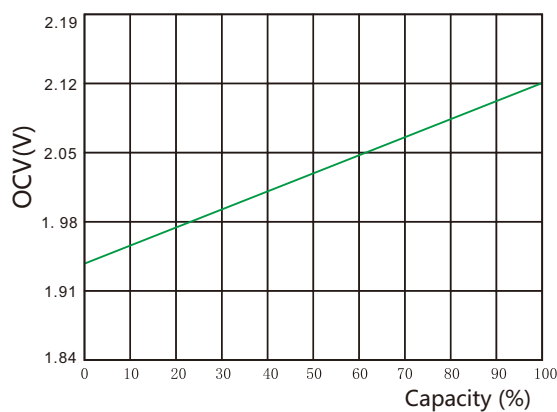

Design life vs temperature

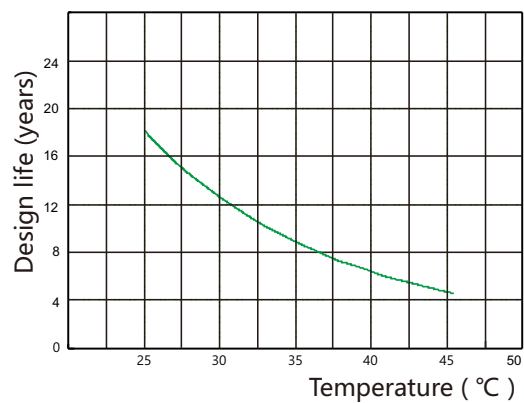

ABDULMAJEED AL-WAHBANI TRADING GROUP (ATG)
 YEMEN SANA'A HADA STREET NEAR AL-GARASI BUILDING
 TEL: 211764 MOB: 777222725
 WEB SITE WWW.ATG-YE.COM
 E-MAIL INFO@ ATG-YE.COM

مجموعة عبدالمجيد الوهباني للتجارة
 اليمن - صنعاء - حدة جوار عمارة الغراسي
 تليفاكس / جوال 211764 / 777222725
 الموقع الالكتروني WWW.ATG-YE.COM
 البريد الالكتروني INFO@ ATG-YE.COM