

ICS series

ICS-400

Narada's ICS series battery designed to provide highcycling and fast charge performance, idea for telecom service where power supply is unstable. With innovative structure design, high quality manufacturing and high quality material, ICS batteries are also capable of PSoC, hybrid, renewable energy storage application and other cycling/standby applications.



Specifications

Battery Model	ICS-400	
Nominal voltage	2V	
Capacity	400Ah (10HR ,40A, 1.80V, 25°C)	
Approx.Weight	27kg	
Internal Resistance	Approx 0.35mΩ	
Max Charge Current Allowed	100A	
Charge Voltage (25°C)	Cycle use	Float use
	2.35V/cell	2.25V/cell
Temperature Ranges	Operation(maximum): -40°C to 55°C (-40°F to 131°F)	
	Operation(recommended): 15°C to 25°C (59°F to 77°F)	
	Storage: -20°C to 40°C (-4°F to 104°F)	
Terminal	M8 Female	
Terminal Hardware	15 ± 1.0 N.m	
Container Material	ABS (V0 optional)	

Dimensions (mm)

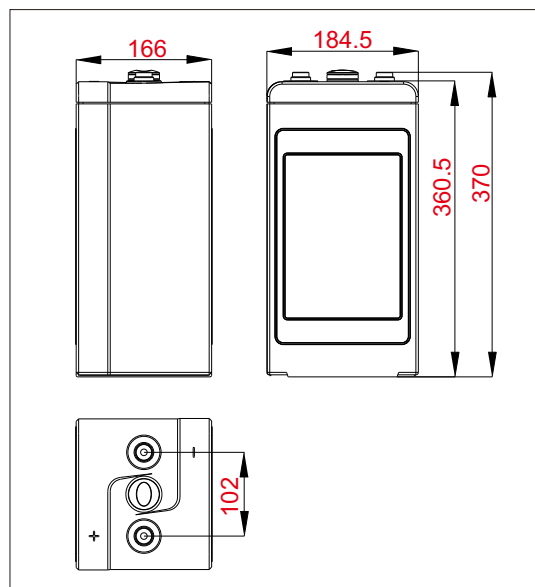

Constant Current Discharge Data Units: Amperes (25°C, 77°F)

End voltage per cell	15min	20min	30min	40min	50min	1h	2h	3h	5h	8h	10h
1.65V	495	450	365	315	270	227	140	104	72.0	49.0	44.0
1.70V	460	410	340	300	245	225	137	102	69.0	47.0	43.0
1.75V	410	370	320	280	230	223	135	100	67.0	45.0	42.0
1.80V	365	330	305	260	225	221	132	98	65.0	43.0	41.0

Constant Power Discharge Data Units: Watts per cell (25°C, 77°F)

End voltage per cell	15min	20min	30min	40min	50min	1h	2h	3h	5h	8h	10h
1.65V	910	810	700	580	520	440	290	225	160	112	105
1.70V	840	780	640	570	505	420	275	220	150	103	95
1.75V	800	720	610	520	470	415	270	215	140	95	90
1.80V	710	650	550	490	420	405	260	210	130	86	80

ICS series

ICS-400

Discharge Voltage vs Time Curve (25°C)

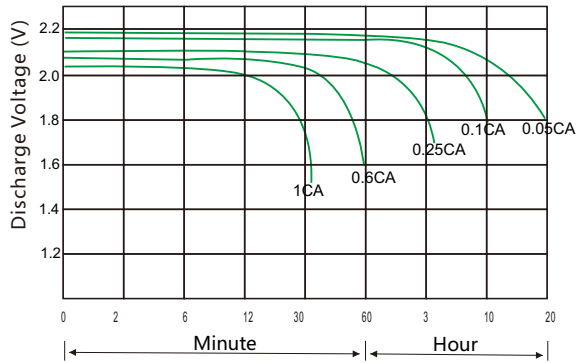

Charge Curve (25°C)

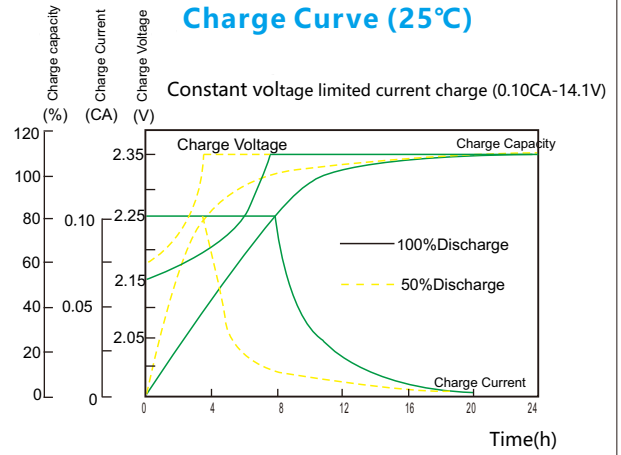

Capacity vs temperature curve

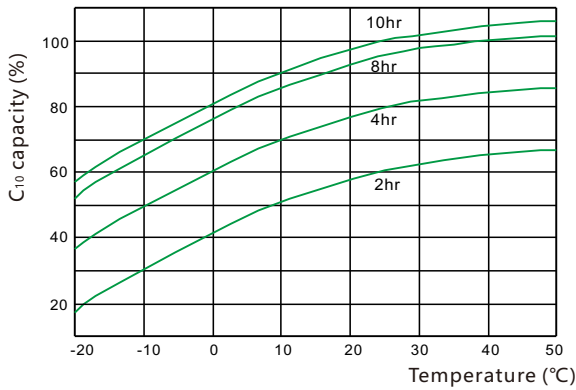

Residual Capacity vs Storage Time

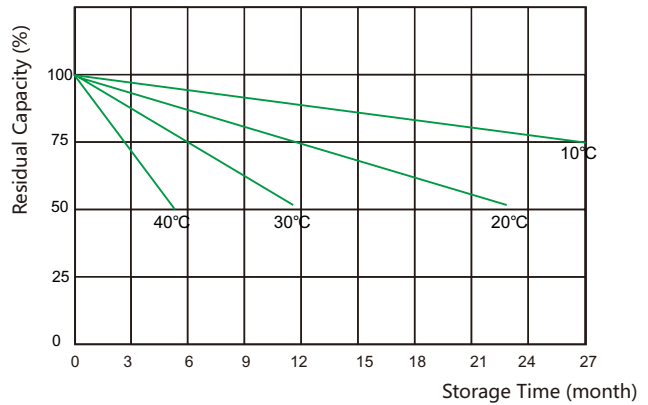

Capacity vs OCV curve

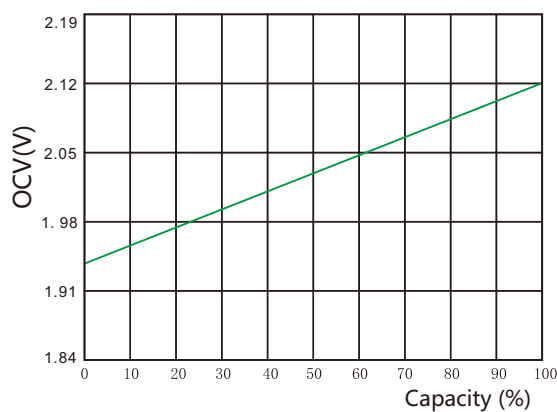

Design life vs temperature

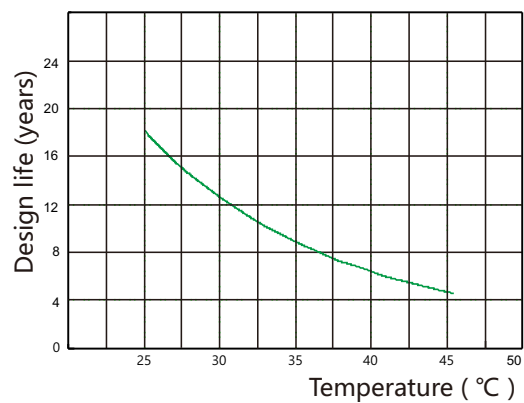

ABDULMAJEED AL-WAHBANI TRADING GROUP (ATG)
 YEMEN SANA'A HADA STREET NEAR AL-GARASI BUILDING
 TEL: 211764 MOB: 777222725
 WEB SITE WWW.ATG-YE.COM
 E-MAIL INFO@ ATG-YE.COM

مجموعة عبدالمجيد الوهباني للتجارة
 اليمن - صنعاء - حدة جوار عمارة الغراسي
 تلفاكس / 211764 جوال 777222725
 الموقع الالكتروني WWW.ATG-YE.COM
 البريد الالكتروني INFO@ ATG-YE.COM